

10 Schematic Diagrams

10-1 Power Part Schematic Diagram

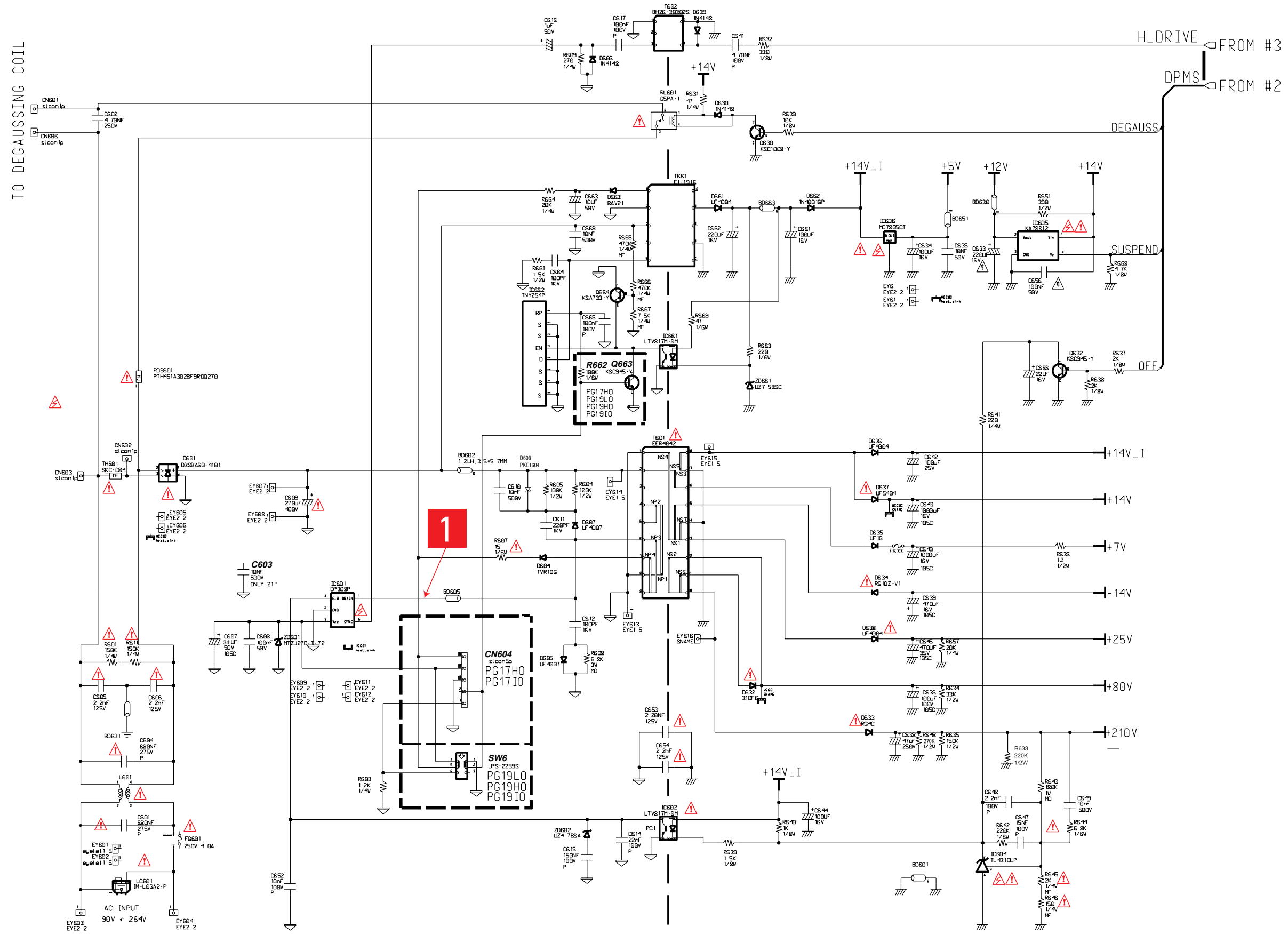

CSE980B, CSE988B

	S5	S4	S3	S2	S1
~33K	H	H	H	H	H
33-35K	L	H	H	L	L
35-37K	L	H	H	L	L
37-40K	L	L	H	H	H
40-46K	H	H	L	L	L
46-50K	L	H	L	H	L
50-55K	H	L	L	H	H
55-59K	H	L	L	H	L
59-65K	H	L	L	L	H
65-68K	L	L	L	H	L
68-70K	L	L	L	H	H
70-76K	L	L	L	H	H
76-78K	L	L	L	L	H
78-81K	L	L	L	H	L
81-85K	L	L	L	L	H
85-96K	L	L	L	L	L

CSE780B, CSE788B

	S5	S4	S3	S2	S1
~33K	H	H	H	L	H
33-35K	L	H	H	L	H
35-37K	L	H	H	L	H
37-40K	L	L	H	H	H
40-46K	H	H	L	L	L
46-50K	H	L	L	H	H
50-52K	H	L	L	H	H
52-55K	H	L	L	H	H
55-59K	H	L	L	H	L
59-65K	H	L	L	L	H
65-68K	L	L	L	H	L
68-70K	L	L	L	H	H
70-76K	L	L	L	H	H
76-78K	L	L	L	L	H
78-81K	L	L	L	L	H
81-85K	L	L	L	L	H
85-96K	L	L	L	L	L

CSE9839, CSE9829

	S5	S4	S3	S2	S1
~33K	H	H	H	H	H
33-35K	L	H	H	L	H
35-37K	L	H	H	L	H
37-40K	L	L	H	H	H
40-46K	H	H	L	L	L
46-50K	H	L	L	H	H
50-55K	H	L	L	H	H
55-59K	H	L	L	H	L
59-65K	H	L	L	L	H
65-68K	L	L	L	H	L
68-70K	L	L	L	H	H
70-76K	L	L	L	H	H
76-78K	L	L	L	L	H
78-81K	L	L	L	H	L
81-85K	L	L	L	L	H
85-96K	L	L	L	L	L

CSE7839, CSE7829

	S5	S4	S3	S2	S1
~33K	H	H	H	H	H
33-35K	L	H	H	L	H
35-37K	L	H	H	L	H
37-40K	L	L	H	H	H
40-46K	H	H	L	L	L
46-50K	L	H	L	H	L
50-55K	H	L	L	H	H
55-59K	H	L	L	H	L
59-65K	H	L	L	L	H
65-68K	L	L	L	H	L
68-70K	L	L	L	H	H
70-76K	L	L	L	H	H
76-78K	L	L	L	L	H
78-81K	L	L	L	L	H
81-85K	L	L	L	L	H
85-96K	L	L	L	L	L

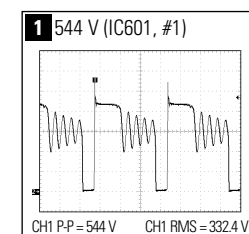

10-2 Micom Part Schematic Diagram

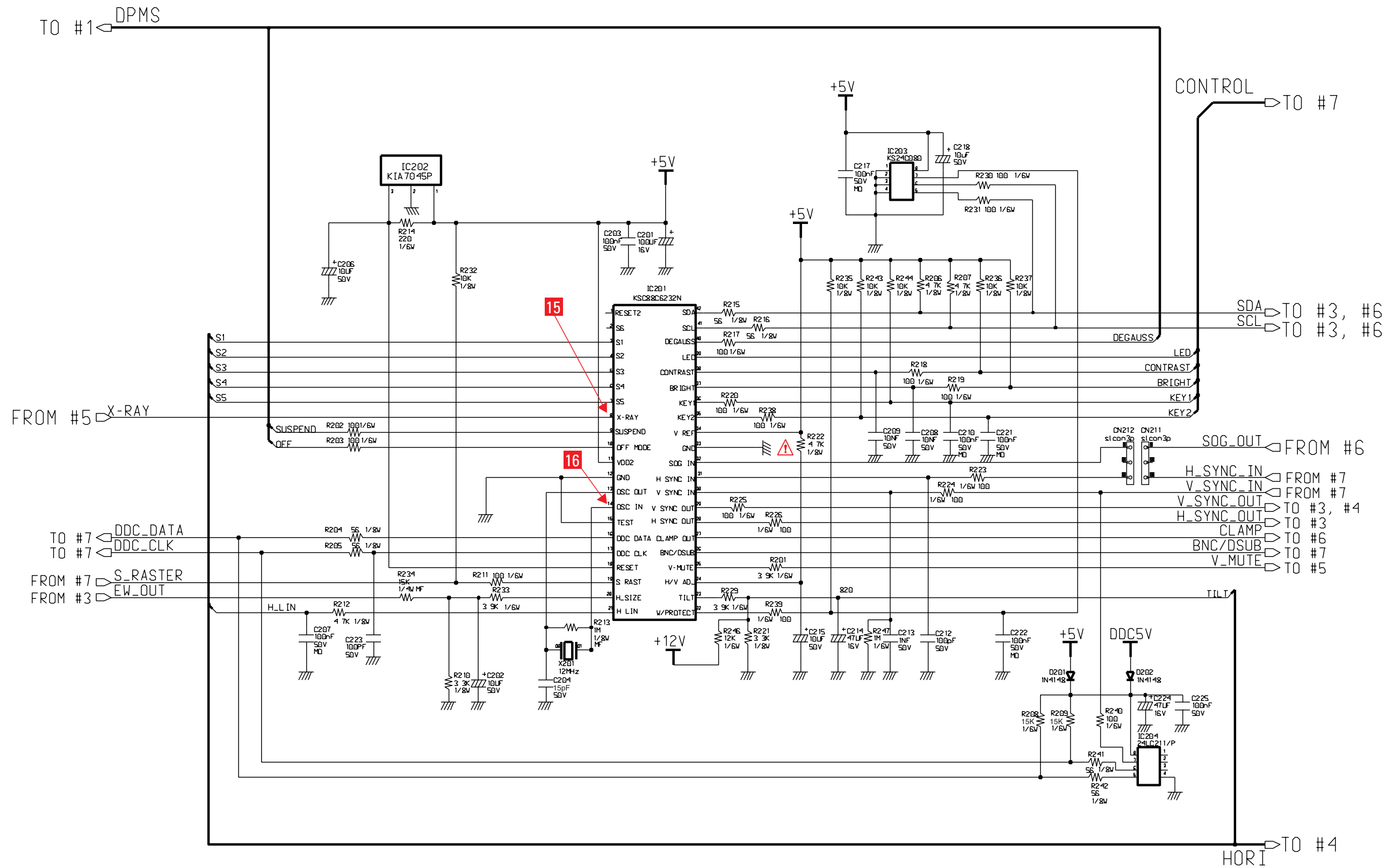

Table 10-1. IC201 (ST72E75)

pin #	MODES			pin #	MODES		
	31 kHz	68 kHz	91 kHz		31 kHz	68 kHz	91 kHz
1	5.05	5.05	5.05	22	5	5.03	5.03
2	0	0	0	23	GND	GND	GND
3	2.18	2.18	2.18	24	4.06	2.75	3.77
4	3.84	4.12	4.23	25	5	5	5
5	NC	NC	NC	26	0	0	0
6	2.32	2.32	2.31	27	5	5	5
7	0	0	0	28	5	5	5
8	NC	NC	NC	29	5	5	5
9	GND	GND	GND	30	5	5	5
10	5.05	5.05	5.04	31	0	0	0
11	5	5	5	32	2.34	2.33	2.28
12	5	5	5	33	2.22	2.22	2.24
13	5	5	5	34	0	0	0
14	5	5	5	35	12	0	0
15	5	0	5	36	12	0	0
16	5	5	5	37	12	12	0
17	NC	NC	NC	38	12	12	0
18	4.73	4.62	4.63	39	12	0	0
19	NC	NC	NC	40	5	5	5
20	0	0	0	41	GND	GND	GND
21	0.6	0.36	0.46	42	2.05	2.62	2.62

Unit: Vrms

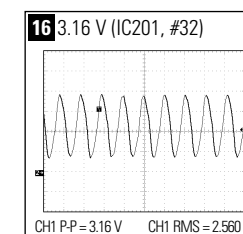
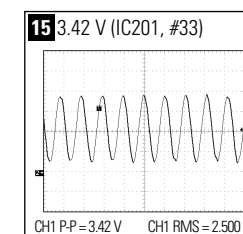
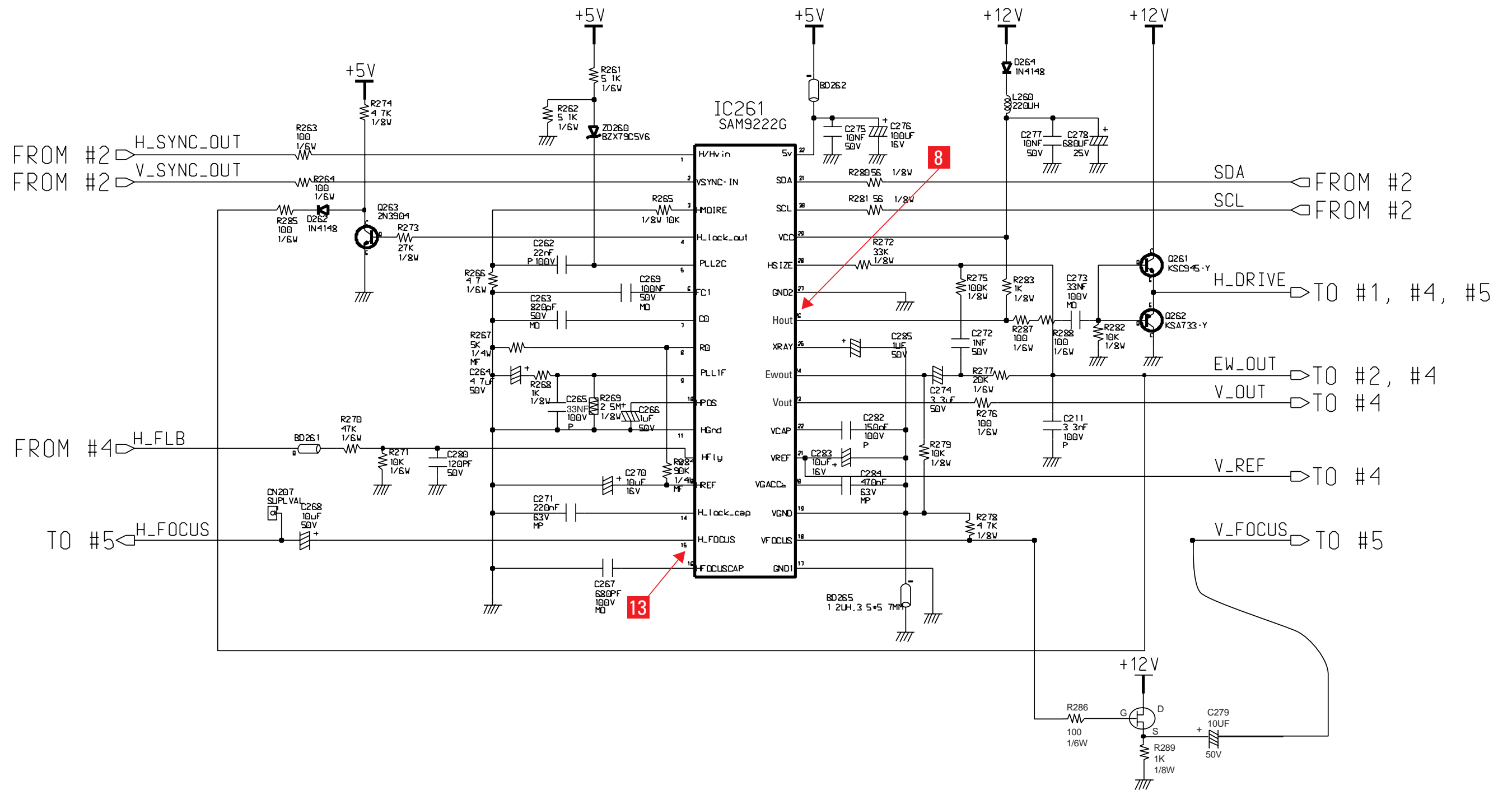

Table 10-2. IC251 (SAM9222G)

pin #	MODES			pin #	MODES		
	31 kHz	68 kHz	91 kHz		31 kHz	68 kHz	91 kHz
1	0.61	0.36	0.46	17	GND	GND	GND
2	0	0	0	18	5.56	5.54	5.54
3	0.17	0.16	0.17	19	GND	GND	GND
4	4.83	4.82	4.82	20	5.46	5.24	5.24
5	3.28	2.69	2.31	21	8.15	8.16	8.16
6	6.41	6.41	6.4	22	3.56	3.56	3.56
7	4.01	4.0	3.99	23	3.56	3.56	3.56
8	1.55	3.39	4.5	24	3.16	3.05	3.05
9	1.55	3.39	4.5	25	2.02	2.01	2.01
10	3.37	3.3	3.29	26	5.06	5.11	5.38
11	GND	GND	GND	27	GND	GND	GND
12	0	0	0	28	3.63	2.49	3.69
13	8.05	8.04	8.04	29	12.02	12.02	12.02
14	8.09	8.03	8.0	30	5.03	5.03	5.03
15	2.74	2.83	2.78	31	5.03	5.03	5.03
16	3.27	3.26	3.24	32	5.04	5.03	5.03

Unit: Vrms

10-3 H/V Process Part Schematic Diagram



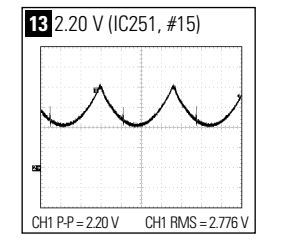
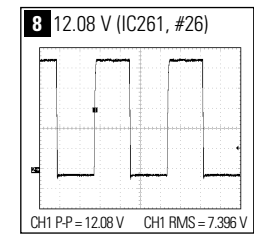

10-4 HORI & VERTICAL Part Schematic Diagram

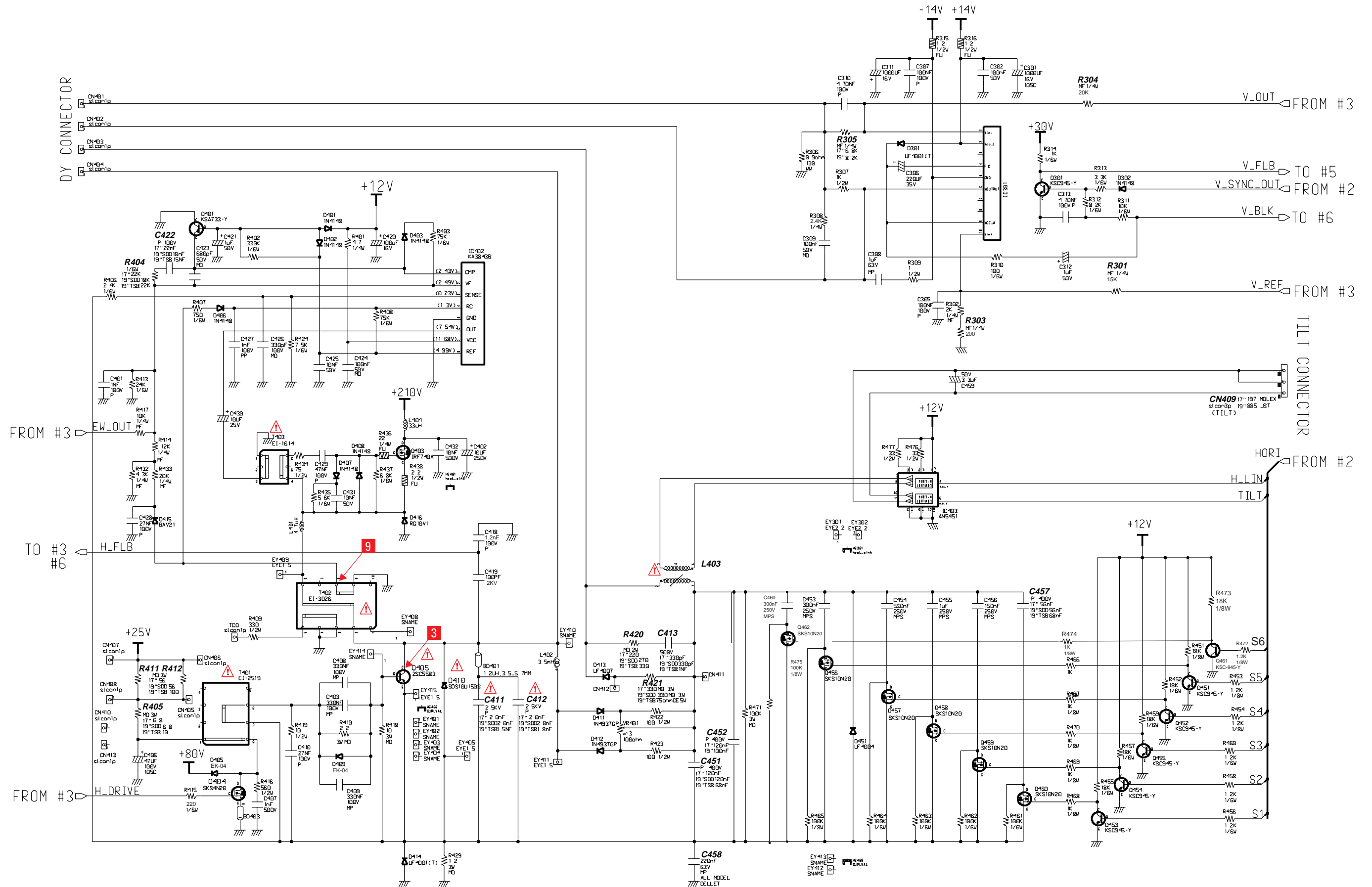

Table 10-3. IC301 (TDA8172)

pin #	MODES		
	31 kHz	68 kHz	91 kHz
1	1.09	1.09	1.08
2	12.43	12.28	12.21
3	9.65	9.65	9.41
4	-13.6	-13.65	-13.65
5	0	0	0
6	11.56	11.65	11.58
7	1.09	1.09	1.09

Unit: Vrms

Table 10-4. IC401 (KA3843)

pin #	MODES		
	31 kHz	68 kHz	91 kHz
1	3.3	2.58	2.3
2	2.5	2.5	2.5
3	0.71	0.41	0
4	1.25	1.41	1.22
5	GND	GND	GND
6	2.12	4.28	5.05
7	11.86	11.86	11.86
8	4.98	4.98	4.98

Unit: Vrms

Table 10-5. IC403 (LM324M)

pin #	MODES		
	31 kHz	68 kHz	91 kHz
1	-13.81	-13.65	-13.64
2	5.04	5.04	5.04
3	4.52	4.44	4.41
4	12.02	12.02	12.02
5	3.26	3.26	3.26
6	3.26	3.26	3.26
7	0.97	-1.85	-2.5
8	1.06	1.07	1.07
9	2.02	2.02	2.02
10	2.02	2.02	2.02
11	-13.81	-13.65	-13.64
12	NC	NC	NC
13	NC	NC	NC
14	NC	NC	NC

Unit: Vrms

Table 10-6. IC501 (TL494CN)

pin #	MODES		
	31 kHz	68 kHz	91 kHz
1	4.86	4.86	4.86
2	4.86	4.86	4.86
3	1.49	1.32	1.29
4	0	0	0
5	0.66	0.61	0.6
6	3.42	3.43	3.42
7	GND	GND	GND
8	11.97	11.96	11.95
9	2.4	3.42	3.67
10	2.4	3.42	3.67
11	11.98	11.96	11.95
12	11.98	11.96	11.95
13	GND	GND	GND
14	4.86	4.86	4.86
15	11.98	11.96	11.95
16	4.86	4.86	4.86

Unit: Vrms

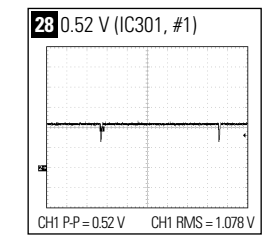
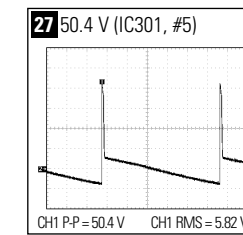
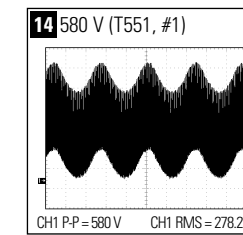
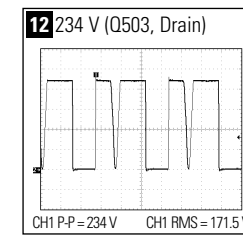
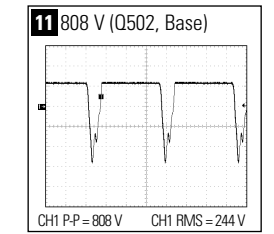
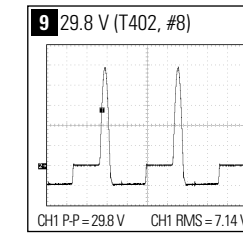
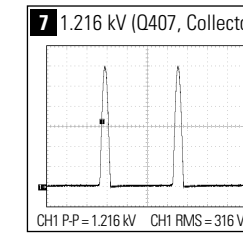
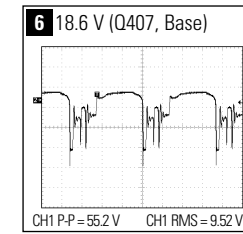
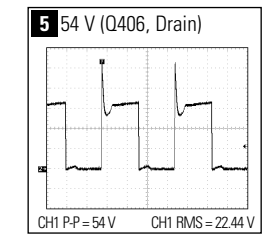
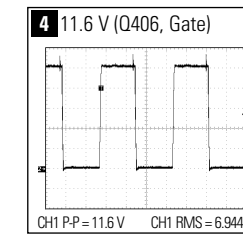
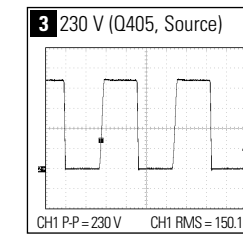
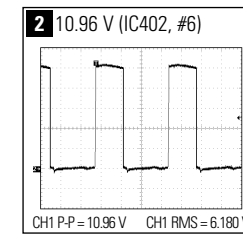

10-5 HIGH VOLTAGE Parts Schematic Diagram

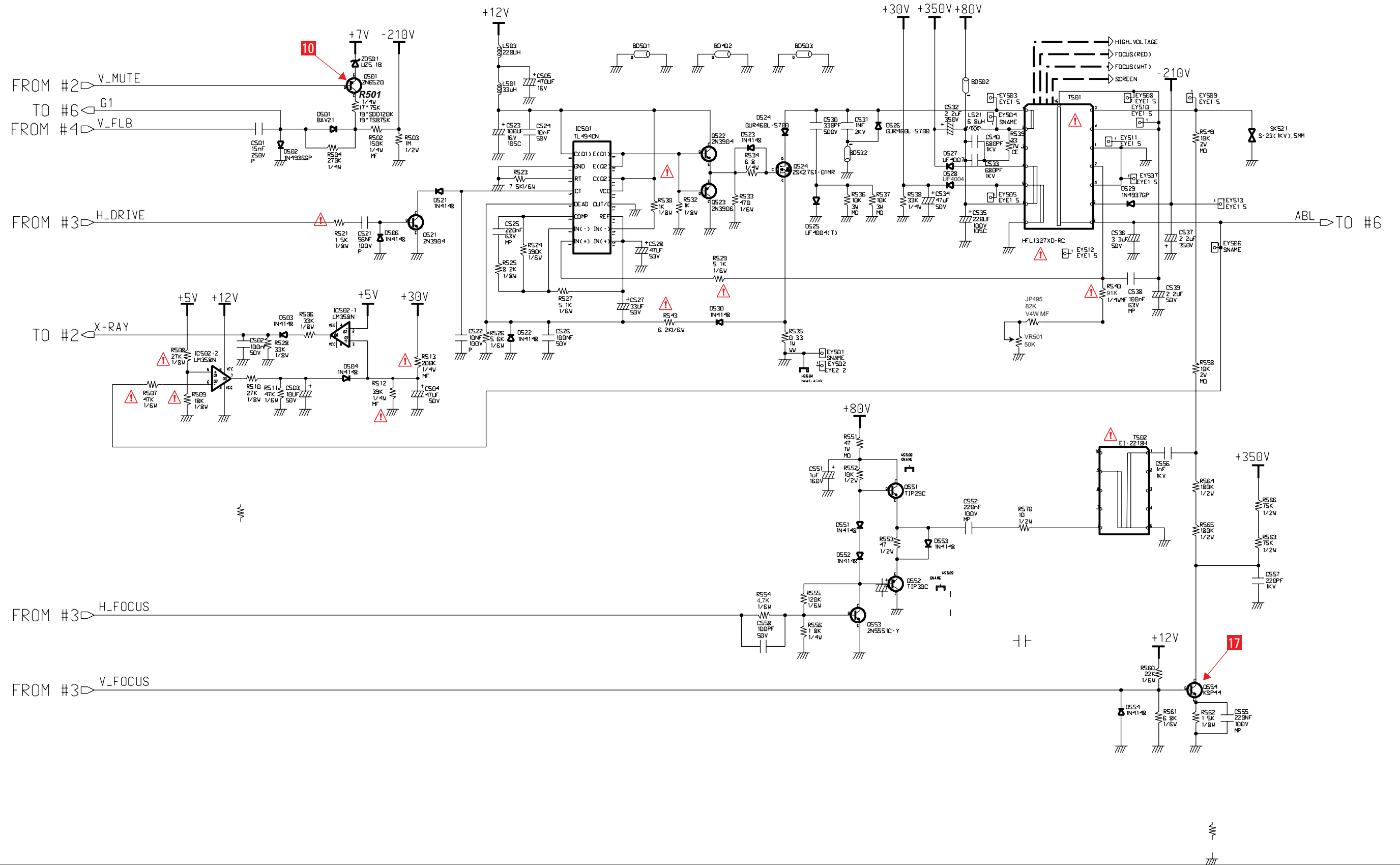

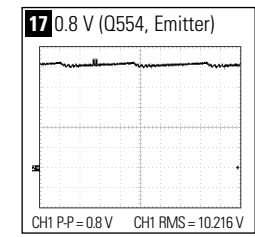
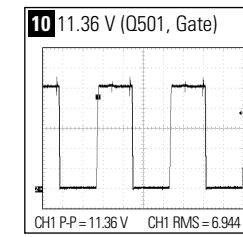

10-6 Video Parts Schematic Diagram (17")

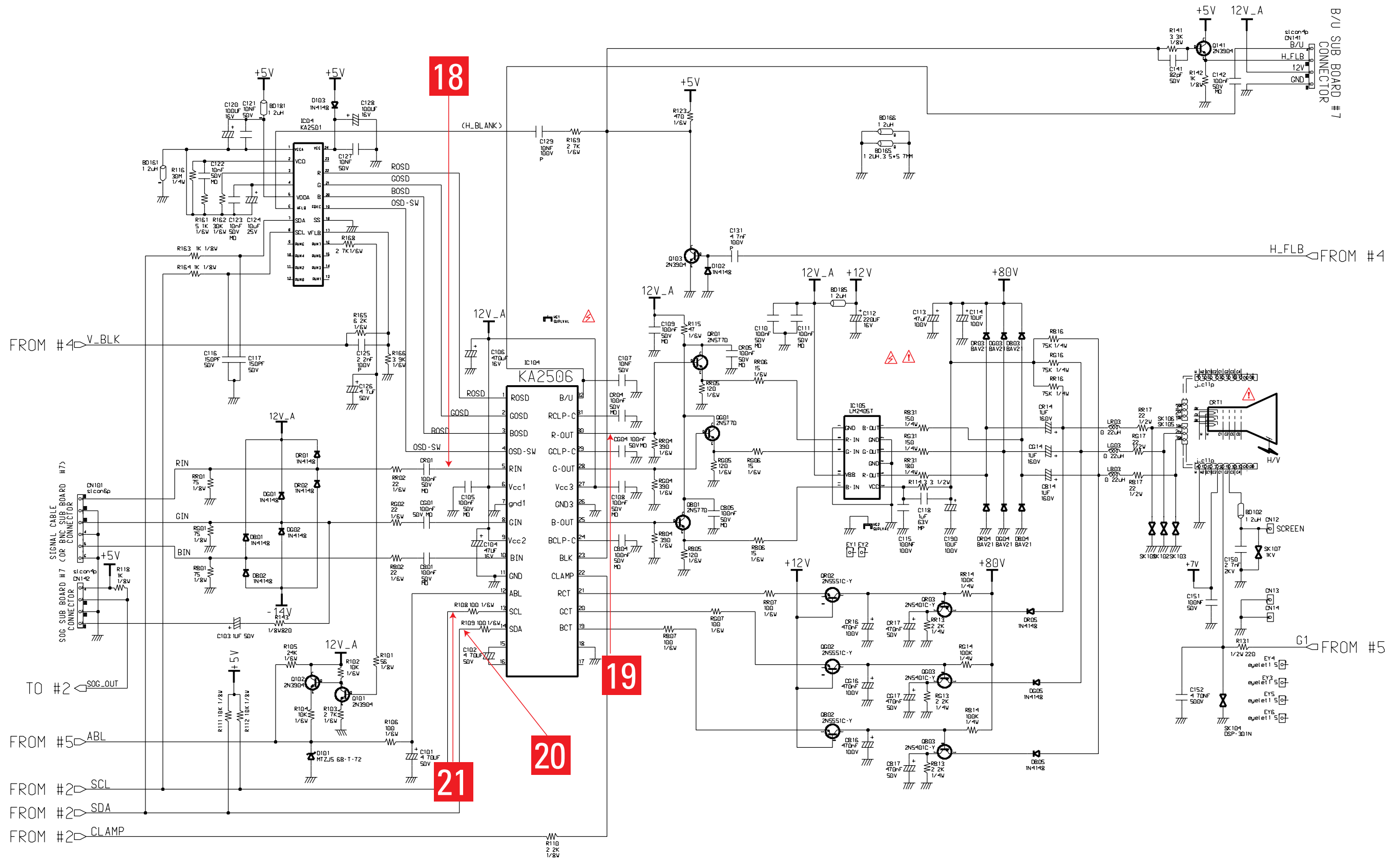

Table 10-7. IC1 (BA7657S)

pin #	MODES			pin #	MODES		
	31 kHz	68 kHz	91 kHz		31 kHz	68 kHz	91 kHz
1	3.6	3.6	3.6	13	0	0	0
2	3.5	2.6	2.8	14	5	0	0
3	3.6	3.6	3.6	15	2.1	2.1	2.1
4	GND	GND	GND	16	5	5	5
5	3.6	3.6	3.6	17	0	0	0
6	GND	GND	GND	18	3	3	2.9
7	0	0	0	19	2.1	2.1	2.1
8	GND	GND	GND	20	5	5	5
9	0	0	0	21	2.1	2.2	2.1
10	GND	GND	GND	22	4	0	0.3
11	0	0	0	23	0	0	0
12	4.5	0	0	24	4.4	0.3	0.4

Unit: Vrms

Table 10-8. IC03 (VPS14)

pin #	MODES			pin #	MODES		
	31 kHz	68 kHz	91 kHz		31 kHz	68 kHz	91 kHz
1	11.9	11.9	11.9	13	0	0	0
2	2.8	2.7	2.6	14	5	0	0
3	2.1	2	2	15	2.1	2.1	2.1
4	45	45	46	16	5	5	5
5	GND	GND	GND	17	0	0	0
6	44	46	46	18	3	3	2.9
7	2.1	2	2	19	2.1	2.1	2.1
8	2.7	2.6	2.5	20	5	5	5
9	11.8	11.8	11.8	21	2.1	2.2	2.1
10	GND	GND	GND	22	4	0	0.3
11	11.8	11.8	11.8	23	0	0	0
12	2.7	2.6	2.5	24	4.4	0.3	0.4
13	1.9	1.9	2				
14	46	47	47				
15	80	80	80				

Unit: Vrms

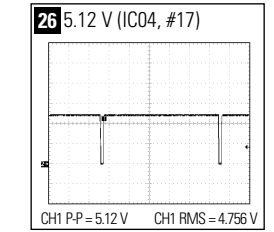
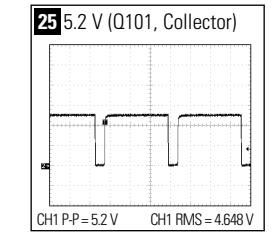
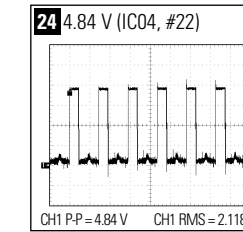
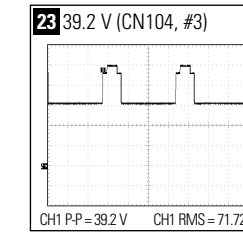
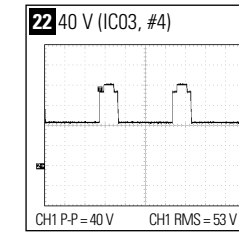
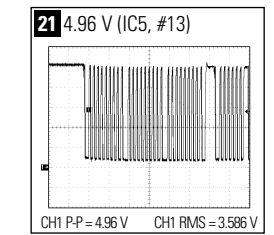
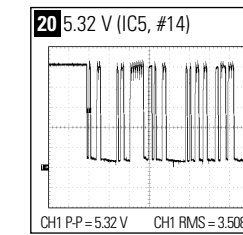
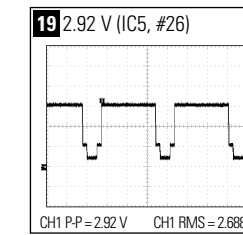
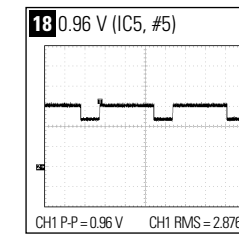

Table 10-9. IC04 (KA2501)

pin #	MODES			pin #	MODES		
	31 kHz	68 kHz	91 kHz		31 kHz	68 kHz	91 kHz
1	GND	GND	GND	13	NC	NC	NC
2	2.3	2.3	2.4	14	NC	NC	NC
3	1.18	1.2	1.2	15	NC	NC	NC
4	1.18	1.2	1.2	16	5	5	5
5	5	5	5	17	4.5	4.6	4.6
6	4.67	4.3	4	18	GND	GND	GND
7	5	5	5	19	0	0	0
8	5	5	5	20	0	0	0
9	NC	NC	NC	21	0	0	0
10	NC	NC	NC	22	0	0	0
11	NC	NC	NC	23	0	0	0
12	NC	NC	NC	24	5	5	5

Unit: Vrms

Table 10-10. IC5 (KA2506)

pin #	MODES			pin #	MODES		
	31 kHz	68 kHz	91 kHz		31 kHz	68 kHz	91 kHz
1	0	0	0	15	10.7	10.7	10.7
2	0	0	0	16	10.8	10.7	10.7
3	0	0	0	17	10.8	10.7	10.7
4	0	0	0	18	4.9	5.0	4.8
5	2.4	2.3	2.3	19	4.6	4.3	4.0
6	11.8	11.7	11.7	20	4.5	4.6	4.6
7	GND	GND	GND	21	2.5	2.6	2.5
8	2.4	2.3	2.3	22	GND	GND	GND
9	11.8	11.7	11.7	23	11.8	11.7	11.7
10	2.4	2.3	2.3	24	2.6	2.6	2.5
11	GND	GND	GND	25	4.6	4.6	4.6
12	3.9	3.9	3.9	26	2.6	2.6	2.5
13	5	5	4.7	27	4.6	4.7	4.6
14	5	5	5	28	4.5	4.5	4.5

Unit: Vrms

10-7 Video Parts Schematic Diagram (21")

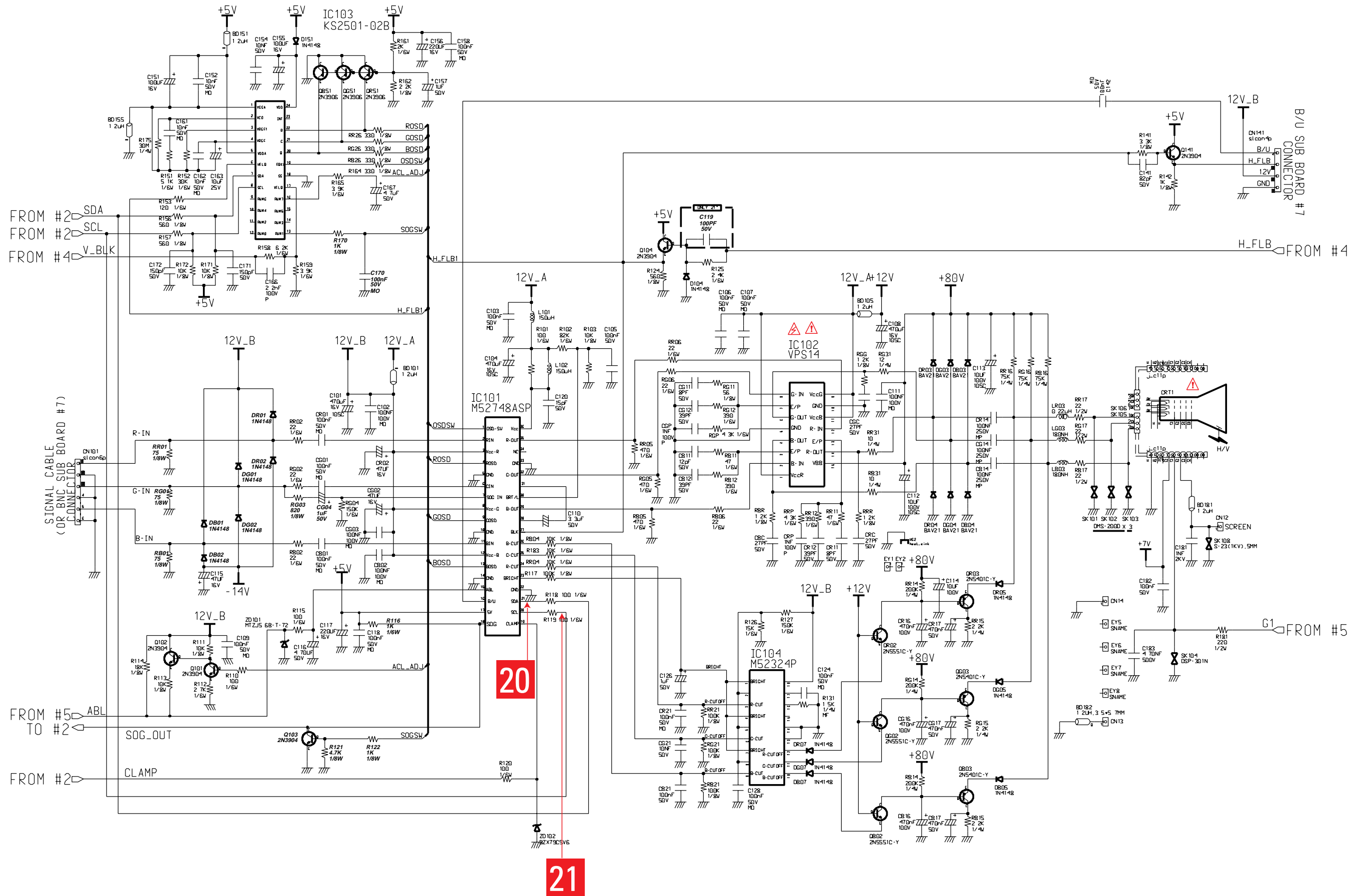

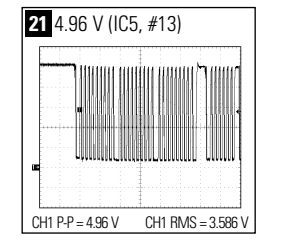
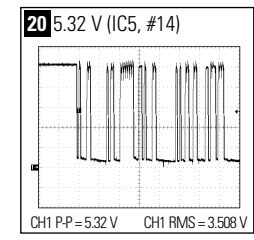

10-8 Connector & Option Boards Parts Schematic Diagram

